

AĞAOĞLU
AVIATION AND DEFENSE INDUSTRY CO, LTD



AG-9

OPERATION AND SAFETY MANUAL

PREFACE

- Read this manual carefully before handling this firearm. Only use the firearm after carefully reading and understanding the instructions.
- Keep this manual with your pistol and review it before each use.
- Do not allow others to handle or fire your pistol until they have read this manual.
- Carefully follow the maintenance and usage instructions given in this manual. Failure to follow these instructions could result in serious injury or death.
- The trouble-free use and long service life of your AG-9 pistol can only be ensured by following the instructions given in this manual regarding the use, control and maintenance of your gun.
- The expressions Right, Left, Front, and Back refer to the viewpoint of the shooter holding a gun and aiming at a target.
- Please send all your suggestions and thoughts about the change and/or improvement of this manual to "AĞAOĞLU AVIATION AND DEFENSE INDUSTRY CO.,LTD. " company.
- Transfer this manual with the firearm upon ownership change.
- Be a responsible gun owner. Use it safely, store it securely, and always transfer a gun responsible and legally.



Şerifali Mahallesi Hattat Sokak No: 51 ÜMRANİYE, İSTANBUL / TÜRKİYE

Tel: 0 (216) 527 1818 • Fax: 0 (216) 527 1829

info@ahss.com.tr www.ahss.com.tr

CONTENTS

Read and Understand this Manual	03	Magazine Disassembly	25
Know Your Gun	04	Ported Barrel	26
Safety Rules	06	Parts Diagram	28
Loaded Chamber Indicator	11	Point of Aim	32
Striker Status Indicator	12	Care and Cleaning	33
Safety Devices	13	Disclaimer	35
Loading	14	Warranty	
Firing	15		
Unloading	16		
Malfunction Warning	18		
Disassembly	21		



Şerifali Mahallesi Hattat Sokak No: 51 ÜMRANİYE, İSTANBUL / TÜRKİYE
Tel: 0 (216) 527 1818 • Fax: 0 (216) 527 1829
info@ahss.com.tr www.ahss.com.tr

BEFORE LOADING AND FIRING THIS PISTOL, READ AND UNDERSTAND THE INFORMATION IN THIS MANUAL

This is an auto loading pistol. It is immediately loaded and ready to fire again after each shot until all shells loaded in magazine have been fired. The pistol is able to fire both with and without the magazine in place. Removing the magazine does not unload the pistol nor engage a safety. The pistol is not unloaded until the chamber is empty.

ABOUT YOUR OWNERS MANUAL

This is an instruction booklet on how to operate this firearm with some basic safe handling rules. It does not attempt to provide information about using a gun to defend yourself, how to hunt, or for competitive or target shooting. It is important to get instruction from a competent instructor prior to engaging in any of these activities. The National Rifle Association, your local or state authorities, or your gun dealer may provide information regarding available instructors or training courses. If you have a license to carry concealed, never do so without prior instruction from a certified instructor. Using a gun for self defense is a complex subject with dangers and risks for which you must be properly trained. Every safety rule has a reason behind it - read the rules carefully and understand why each is important for safety.

It is recommended that every person receive instructions from a competent firearms instructor before handling this or any other firearm.

Know and obey all gun laws. Do not give a gun to someone who is not allowed to own a gun or who may use it for a criminal purpose.

USED GUNS

If you purchased this firearm as a used gun, have it inspected and tested by a competent gunsmith before you use it. Guns are sometimes altered and may require repair before they can be used safely.

STORE GUNS SAFELY IN THE HOME

Store guns unloaded, locked and in a secure place. Obey gun storage laws. Store guns and ammunition separately.

 Because your children may be in other homes where guns are stored, you should show them what to do if they see or find a gun by showing them the Eddie Eagle video available from the NRA by calling (703) 267-1000.

KNOW YOUR GUN



KNOW YOUR GUN

INFORMATION TO ORDER SPARE PARTS:

- Model and Caliber of the Gun
- Serial Number
- Spare Part Name
- Number of Spare Parts

Magazine latch; It is designed to change the working direction from left to right in order to adapt to both right and left handed shooters. To change the direction of the magazine lever (36);

- Disassemble your pistol as described in "Pistol disassembling and Assembling Section".
- Hold the frame (24) so that you can see the inside of the magazine holder clearly..
- Remove the magazine lever (35) spring by pressing the magazine latch with the tip of a screwdriver .

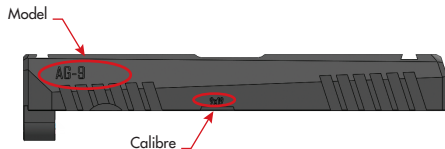

Figure 5

- Change the direction of the magazine latch and insert it into the frame from the other side of the frame.
- Place the magazine latch spring in the frame.
- Place an empty magazine in the magazine well, located in bottom of pistol grip and press the magazine latch to check that it works properly. Check the assembly and functions of the magazine latch several times in this way.

SAFETY RULES

READ AND UNDERSTAND THESE SAFETY RULES

Be A Safe Shooter.

ACCIDENT (ak' si dent) N. 1. An unintentional or unexpected happening that is undesirable or unfortunate, especially one resulting in injury, damage, harm or loss.

Don't be the cause of an accident.

A responsible gun owner is safety minded and always handles guns in a safe manner by following the basic rules of safe shooting and by using common sense in the handling of a firearm. Store firearms unloaded, locked, and in a secure place. Keep keys for locks separate from lock and in secure place away from children. Keep firearms out of reach of children. You are responsible for children's safety.

Be A Responsible Gun Owner.

- Always keep the muzzle pointed in a safe direction.
- Never point a gun at any person or thing you do not intend to shoot.
- Do not drop your gun. If it falls, it may fire even with the safety on. If you do drop it, unload it and examine it to

be sure it works correctly. Do not attempt to fire it again until you have completed this safety check.

- Never put your hand over the muzzle of the gun.
- Keep your finger(s) off the trigger and out of the trigger guard until you are actually aiming at your target, ready to shoot.

 **TREAT EVERY GUN AS IF IT IS LOADED... ALL THE TIME.**

BE A RESPONSIBLE GUN OWNER!

- Never rely on a gun's "safety" to protect you from unsafe gun handling. A safety is only a mechanical device, not a substitute for common sense.
- When the gun is loaded don't touch the trigger until you are ready to fire.
- Be sure of your target and backstop before you shoot. Ask yourself what your bullet will hit if it misses or goes through the target.

SAFETY RULES

- Before shooting, be sure the barrel is clear of obstructions, including excessive oil and grease.
- If anything does get into the barrel, remove cartridges, and clean the bore immediately, before attempting to shoot. Obstructed barrels can burst and injure you or bystanders.
- Never let water, snow, mud or other materials enter the barrel.
- Never pull a gun toward you by the muzzle.
- Do not climb a tree, cross a fence or ditch, or jump over an object with a loaded gun.
- Always hold your gun so you control the direction of its muzzle in case you fall or stumble.

 **WARNING!** AG-9 Pistols are classified firearms and dangerous weapons. Injury or death to you or others may result from unsafe or improper use.

BE A SAFE SHOOTER!

- Guns and alcohol or drugs do not mix. Do not take them before or during shooting activities. Your vision, coordination and judgment could be impaired, making gun handling unsafe.
- When taking medication, seek a doctor's advice to be sure you can operate and handle your firearm safely.
- Get instructions from a competent firearms instructor before using any gun.
- Before attempting to shoot, practice operations by dry firing with the chamber empty, without ammunition, or with dummy shells. Become familiar with the safety features, trigger control, and handling of the firearm.
- Always keep and carry your pistol with an empty chamber until you intend to shoot, so your pistol cannot be fired unintentionally.
- Firearms should be unloaded when not in use. This means both the chamber and magazine are empty.

SAFETY RULES

- When transferring a gun by hand, always ask the person receiving it to open the action and check that it is unloaded.
- Never take anyone's word that a firearm is unloaded. When receiving a gun, always open the action and check that it is unloaded.

READ THESE RULES!

- Treat every gun as if it is loaded...all the time!
- Load and unload with the gun pointed in a safe direction.
- Be certain gun is unloaded before cleaning.
- Completely unload your gun before storing, travelling, standing it against an object, laying it down, entering a house, car, truck, boat, RV/camper, building, or handing it to someone.
- Never leave a loaded gun unattended.

- Tragedy may result if a child finds your gun and plays with it. Keep every gun secure. Children do not believe guns can kill.
- Store guns and ammunition separately. Both should be placed beyond children's reach.
- Obey all laws regarding the storage and security of guns in the home.
Know and obey the laws regarding the transportation and carrying of firearms.
- Never carry any handgun in your pocket, purse or tucked in your belt or waistband. Use a pistol case or a proper holster with safety flap or strap.
- New non-defective brass is essential to ensure safe functioning of your gun.

 Old or reloaded ammunition may be dangerous. Use only clean, dry original, high-quality, commercially manufactured ammunition. Using reloaded ammunition will void the warranty.

SAFETY RULES

TREAT EVERY GUN AS IF IT IS LOADED... ALL THE TIME!

- Many ammunition identifications sound similar. Make sure you use the right size ammunition in your gun.
- If gun fails to fire when the trigger is pulled, keep it pointed at the target for at least 30 seconds before opening the action and removing the cartridge from the chamber. Sometimes slow primer ignition will cause a "hang fire" and the cartridge will go off after a short pause.
- When group firing, always appoint someone to maintain safety control. Obey his/her commands immediately and completely.
- While shooter is loading, firing, and unloading, spectators should be at least 10 feet behind the shooter.
- Always wear protective glasses when shooting.
- Always wear hearing protection when shooting.
- Never shoot at hard flat surfaces or water ...bullets will ricochet.
- Do not alter or modify your gun.

- Have your gun serviced regularly by a qualified gunsmith.
- Discharging firearms in poorly ventilated areas, cleaning firearms, or handling ammunition may result in exposure to lead and other substances known to cause birth defects, reproductive harm, cancer and other serious physical injury. Have adequate ventilation at all times. Wash hands thoroughly after exposure.

 Always wear eye and ear protection when using any firearm. Safety and instruction manuals are available from AĞAOĞLU AVIATION AND DEFENSE INDUSTRY CO., LTD.

BE A SAFE SHOOTER!

- Do not try to change your gun's trigger pull, because alterations of trigger pull usually affect sear engagement and might cause accidental firing.

WARNING: When you squeeze the trigger, you must expect the gun to fire. You must take full responsibility for firing it. Your care can avoid accidental discharge and thereby avoid accidental injury and death.

SAFETY RULES

- Never use a gun that jams or fails to function properly. Should this occur, return to AĞAOĞLU AVIATION AND DEFENSE INDUSTRY CO., LTD. for warranty/repair.
- If your shot sounds weak or underpowered, it could mean a bullet is in the chamber/bore. Gun should be immediately unloaded and the chamber/bore checked for obstructions before refiring.
- Do not "horseplay" with a gun. Your gun cannot think...but you can. Firearm safety depends on you and is the responsibility of the operator.

WARNING!

There is no safe way to discharge a pistol in a home or apartment. Bullets will go through walls, floors, furniture, and appliances and still cause serious injury or death to persons in the house, next-door, or outside. *Accidental discharges indoors ALWAYS result in property damage or personal injury.*

WARNING: When you squeeze the trigger, you must expect the gun to fire. You must take full responsibility for firing it. Your care can avoid accidental discharge and thereby avoid accidental injury and death.

HANDLING

We want you to be a safe, satisfied shooter.

Before attempting to load this firearm with live ammunition, follow the sequence of operations shown here without ammunition or with dummy shells.

By practicing operations without ammunition (or with dummy shells), you will become familiar with:

- Safety features,
- Trigger control (dry firing), and handling of your firearm.

As a result you will be a safer, more confident shooter when aiming at your first target.

Write or call us concerning any items you do not understand and/or which might relate to your safety and the safe operations of any of our products.

LOADED CHAMBER INDICATOR

Your AG-9 pistol has a loaded chamber indicator.

(Figure 11-1.) The indicator allows you to observe whether a cartridge is in the chamber. When a cartridge is in the chamber the indicator raises above the barrel. (Figure 11-2.)

When the loaded chamber indicator is out, the gun is ready to fire.

Caution!

⚠ Even though the chamber is empty there may be cartridges in the magazine. The gun is not completely empty until both the chamber and magazine are empty.

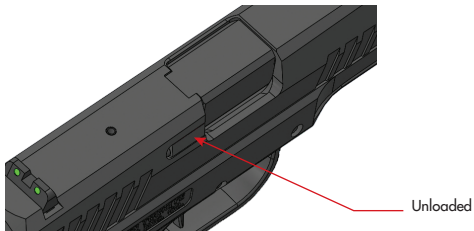

Figure 11-1

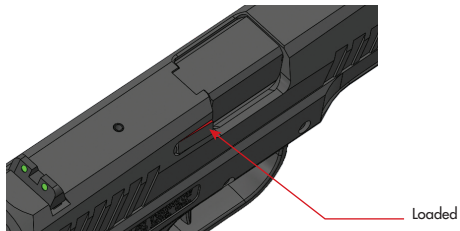

Figure 11-2

STRIKER STATUS INDICATOR

Your AG-9 Pistol has a cocking indicator in the rear of the slide. (Figure 12-1)

When the gun is cocked, the pin will protrude out of the slide. (Figure 12-2)

(The cocking indicator does not always mean that the gun is loaded.)

⚠ However, when the pin is out, always treat the gun as if it were loaded.

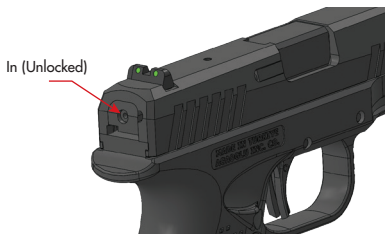

Figure 12-1

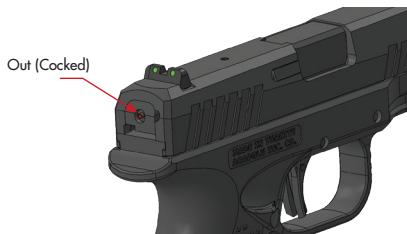

Figure 12-2

SAFETY DEVICES

1. Trigger Safety: The trigger safety locks the trigger from moving backward. A trigger safety incorporated into the trigger (Figure 13-1)

Deactivates the safety when completely depressed while pulling the trigger. The trigger can only be pulled if depressed together with the trigger safety. (Figure 13-2.)

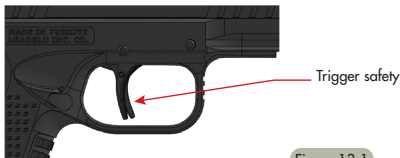

Figure 13-1



Figure 13-2

2. Striker Block Safety: As an additional safety feature, there is an internal striker block safety (Figure 13-3). This block rises from the front of the striker when the trigger is pressed while the lever safety is disabled (Figure 13-4).

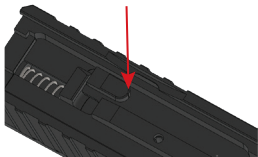

Figure 13-3



Figure 13-4

WARNING!

⚠ Safety devices, like all things mechanical can fail. Safety devices are not a substitute for safe gun handling. Always follow the rules for safe gun handling

LOADING

1. Place the EMPTY magazine in the magazine well, located in bottom of pistol lever. Push firmly enough on bottom of magazine to make sure it is properly seated. A distinctive "click" will confirm the magazine has been properly inserted. Pull the slide all the way to the rear, until it locks back.
2. Depress magazine release and remove magazine.
3. Insure that you are using the proper caliber ammunition for your pistol. Place rim of first cartridge on front of follower. Then push down on the follower and slide cartridge under the lips of the magazine and to the rear. Load successive rounds the same way. Use only clean, dry, original, high-quality, commercially manufactured ammunition.
4. Re -insert magazine into magazine well, located in bottom of pistol lever. Push firmly enough on bottom of magazine to make sure it is properly seated.
5. Point gun in a safe direction and keep finger off trigger. Depress the slide stop lever to allow slide to move forward and load a shell from the magazine into the chamber.

6. The loaded chamber indicator will be in the out position.
7. The striker status indicator will be protruding out of the rear of the receiver in the "cocked" position.

Caution: The gun is now ready to fire.

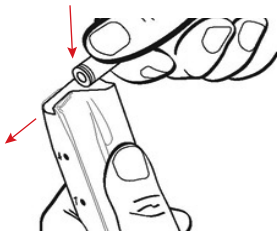

Figure 14

WARNING!

- ⚠** Never touch the trigger when loading or unloading the pistol.

FIRING

Point gun in a safe direction at all times.

If you have never fired a gun before, practice without live ammunition before your first shot. Then load only one cartridge into the magazine for your first live ammunition firing.

1. Point gun in a safe direction.
2. Load cartridge into chamber from magazine.
3. Lever safety is to be disengaged.
4. Grasp grip of pistol firmly. (A loose grip may cause the pistol to malfunction.)

 **Caution:** The gun is now ready to fire.
Be prepared for noise and recoil when pistol fires.

5. Aim gun at target by aligning sights.
6. Lightly place finger on trigger, and slowly squeeze trigger to fire the pistol. Spent cartridge is expelled up and to the right.
7. Pistol will automatically be ready to fire again after each shot until all cartridges loaded in magazine have been fired.
8. When last cartridge has been fired, slide will lock open and remain to rear.

UNLOADING

If slide is already in "locked back" position:

1. Point gun in safe direction.
2. Press magazine release button to remove magazine.
3. From top and rear, carefully inspect chamber to make sure it is empty.
4. Hold slide, disengage slide stop, ease slide forward.

WARNING!

- ⚠️ Pistol is not empty or unloaded until the chamber is empty and the magazine removed.

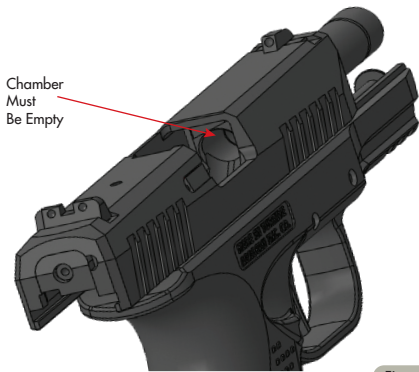

Figure 16

UNLOADING

If slide is forward:

1. Point gun in safe direction.
2. Press magazine release button to remove magazine.
3. Pull slide fully to rear to eject any cartridge remaining in chamber.
4. While holding slide in rearward (open) position, carefully inspect chamber making sure it is empty
5. Slowly release slide, allowing it to return to forward position.

WARNING!

- ⚠️ Pistol is not empty or unloaded until the chamber is empty and the magazine removed. Never touch the trigger when loading or unloading the pistol.

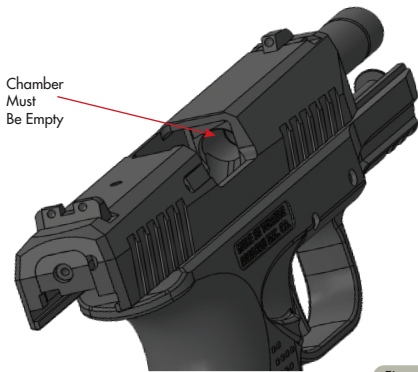

Figure 16

MALFUNCTION WARNING

If cartridge hangs up, jams or binds when being chambered from magazine into chamber, do not attempt to force it into chamber by pushing or striking slide.

1. What to do:

Point gun in a safe direction.

Remove magazine.

Pull back on slide and allow cartridge to fall from gun.

If cartridge does not fall free, pull slide back and lock it back.

Carefully dislodge cartridge.

If cartridge cannot be removed, carefully store your gun and take it to a gunsmith.

2. Most failures to feed or chamber a cartridge are the result of a damaged magazine, improper gun handling or defective ammunition.

3. Whatever the cause, a jammed cartridge can be a dangerous situation. Should shell be discharged while out of chamber, cartridge will rupture and fragments will be blown out of pistol with sufficient force to cause injury.

If any information in this manual is not clear, call AĞAOĞLU AVIATION AND DEFENSE INDUSTRY CO., LTD. Consumer Safety Department at +90 216 527 18 18 info@ahss.com.tr for assistance.



WARNING!

Always have gun pointed in a safe direction. Failure to obey safety information may result in injury to you or others.

TO ELIMINATE MALFUNCTIONS, STOPPAGES, OR FAILURES

MALFUNCTION	REASON	TO ELIMINATE MALFUNCTION
Firing Failure	Wrong Ammunition	Point handgun in a safe direction. Wait 30 seconds and take out the magazine, taking into account that there may be an unloaded bullet in the chamber. Take out the wrong Ammunition.
	Dirty Pin	Clean the hole where pin comes out of the slide.
	Damaged or Broken Pin	Send handgun for repair.
	Malfunctioned Pin spring	Send handgun for repair.
Slide stop lever does not open after firing	An empty cartridge is stuck in the chamber due to deterioration or dirt in the chamber.	Unload handgun. Pull the slide back so that the empty cartridge is ejected from the chamber; clean the chamber when necessary.
Empty cartridge not released	Insufficient slide recoil	Unload handgun, retract slide and remove empty cartridge. Check the recoil spring for proper operation and clean the chamber.
	Improperly loaded Ammunition	Use other ammunition.
	Damaged ejector or cartridge ejector	Send handgun for repair.
Failure to load into chamber	Dirty Chamber	Unload gun and clean chamber.
	Damaged Ammunition	Replace the damaged ammunition.
	Damaged Recoil Spring	Replace recoil spring.
Failure to chamber a cartridge	Damaged Magazine and Magazine Corners	Replace magazine.
	Defective Ammunition	Replace ammunition.
	Unproper Use	Use the gun in the correct / proper way by getting training from a qualified instructor.
Slide; Does not leave behind (in rear position) after the last shell is fired	Malfunctioned Magazine Spring	Replace magazine spring.
	Insufficient Slide Recoil	Check the mechanism and clean the chamber when necessary.
	Damaged Slide Stop Latch	Send handgun for repair.
	Damaged Slide Stop Latch Spring	Send handgun for repair.
Target Point Offset	Incorrectly Loaded Ammunition	Replace ammunition.
	Damaged rear sight or front sight	Change and reset the point of aim sight picture.
	Ammunition Type Change	Change the bullet or adjust the point of aim sight picture.

TO ELIMINATE MALFUNCTIONS

1. Change type/brand of ammunition and/or magazine.
 2. If changing to another type/brand of ammunition and/or magazine does not at once result in smooth feeding of cartridges from magazine to chamber, the following steps should be taken:
 - Make certain chamber and magazine are unloaded. Magazine should be removed first. Check chamber to be sure it and magazine well are clear of cartridges.
 - Thoroughly clean magazine, paying particular attention to removing accumulated grease. Thoroughly clean breech mechanism of pistol.
 - Use a bristle brush and solvent to remove grease and fouling from breech face, extractor, chamber and feed ramp. (See CARE AND CLEANING section for detailed instruction.)
 - Check that magazine spring tension is adequate. The spring should hold the follower tightly against the lips of the magazine.
 - Check that magazine lips are free of nicks and burrs and are not deformed.
- Remove excess oil and solvent from all cleaned components, load magazine and try pistol again.
- ⚠ WARNING!**
An obstructed, cracked or damaged barrel should never be used and should be returned to Aġaoġlu for repair or replacement.
- Some hi-capacity non-AġAOĖLU magazines may be modified to fit the AG-9.
- ⚠ WARNING!**
Proceed slowly and exercise caution to prevent the discharge of a jammed cartridge. The discharge of a jammed cartridge could cause serious injury to you or bystanders.

DISASSEMBLY OF AG-9



Slide



Disassembly Lever



Barrel



Recoil Spring (Recoil Spring Mechanism)



Frame

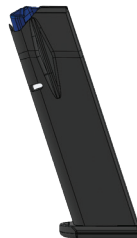

Magazine

DISASSEMBLY OF AG-9

Before performing any cleaning or maintenance, make sure the pistol is completely unloaded (this includes the magazine and chamber).

1. Unload the pistol.
2. Draw the slide to the rear stop position and lock it open, thumbing up the slide stop lever.
3. Visually inspect the chamber to confirm the pistol is unloaded.
4. Rotate the slide disassembly lever clockwise to a vertical 8 o'clock position. (Figure 22.)

WARNING!

- ⚠ If you decide to disassemble your AĞAOĞLU pistol, do so properly. Improper disassembly and assembly will create unsafe conditions that could result in injury or death or a gun that simply will not work. Don't take chances. Do not attempt to disassemble this or any other firearm until you have received training and instructions from a competent gunsmith.



Figure 22

DISASSEMBLY OF AG-9

Before performing any disassembly, make sure the pistol is completely unloaded (this includes the magazine and chamber). Wear eye protection.

5. Pull the slide slightly to the rear to release the slide stop lever. Then allow the slide to slowly move forward until the spring tension is released. Pull the trigger with the

pistol pointed in a safe direction to fully unlock the slide from the frame. (Figure 23-1.)

6. Move the complete slide assembly forward and off the frame. (Figure 23-2.)



Figure 23-1

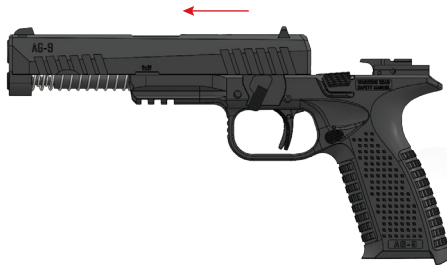

Figure 23-2

DISASSEMBLY OF AG-9

7. Remove the recoil spring assembly, from the slide.
(Figure 24-1)



Figure 24-1

8. Remove the barrel from the slide. (Figure 24-2)

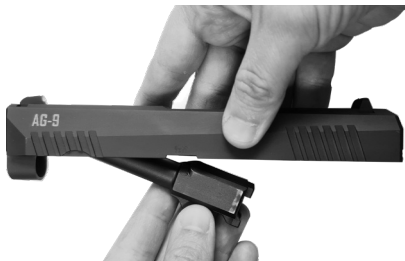

Figure 24-2



Always wear eye and ear protection when using any firearm.

The pistol is now fully field stripped and ready for cleaning. Further dismantling is not necessary and should only be done by Ağaoğlu Aviation and Defense Industry Co., Ltd. or a qualified gunsmith.

MAGAZINE DISASSEMBLY

Magazines do not normally need to be disassembled for cleaning. Disassembling and cleaning magazines every 3-4 months is normally sufficient, unless the magazines have been exposed to dirt or other adverse conditions or inspection indicates a need for cleaning.

Disassembling of the AG-9 magazine is accomplished by depressing the magazine locking plate and sliding the floor plate forward.



Figure 25-1



SAFETY CAUTION:

The magazine spring, follower, and inner floor plate are under spring tension, and can cause eye or other

injury if not controlled during removal. Wear protective safety glasses to reduce the risk of eye injuries. Be sure to maintain downward pressure on the magazine spring, with your thumb, while disassembling.

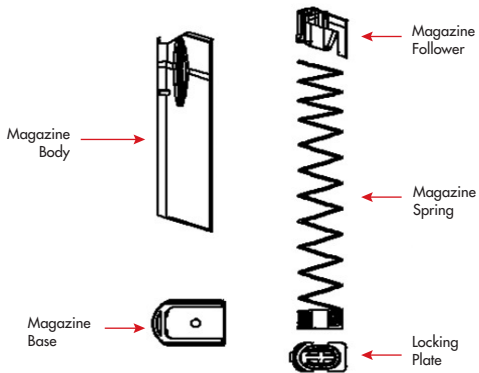

Figure 25-2

PORTED BARREL SAFETY INSTRUCTIONS

Warnings, Ammunition Restrictions, and Maintenance

Completely read this safety manual before using a ported barrel pistol. Transfer this manual to any subsequent owner or user of the pistol. If you are inexperienced in the handling of firearms, obtain expert instruction before attempting to shoot. This manual nor this product can take the place of proper instruction in the safety aspects of shooting, the use of firearms, and the use of a firearm for self-defense. Severe injury to hands, eyes, face, other persons or property will occur with improper use of a ported pistol.

WARNING!

 Always point gun in a safe direction. Keep your gun unloaded until you are ready to shoot.

Safety Notes

Always use eye and ear protection when shooting or when in close proximity to shooting. A ported barrel pistol, in common with most pistols using muzzle brake devices, produces greater noise than normal pistols and this poses a danger to hearing. Never position any part of the body over or near the exhaust ports. Never cycle the slide with your hands over the exhaust ports. Never point a gun at anything you do not intend to shoot. If the ported pistol is drawn rapidly it must not be discharged in proximity to the holster or the shooters' eyes, legs, arms, clothing or bystanders. Do not shoot a ported barrel pistol from the hip. The blast from the exhaust ports can cause injury or property damage several feet away.

Use caution when shooting to avoid overhead objects that may be damaged by the blast from the barrel exhaust ports.

PORTED BARREL SAFETY INSTRUCTIONS

Ammunition: Use only fresh factory ammunition such as Winchester or Federal. DO NOT use hand loads, reloads, or remanufactured ammunition in your Ağaoğlu firearm. Only shoot cartridges of the caliber engraved on the barrel. DO NOT use shot cartridges or any ammunition which is loaded with a frangible projectile or any ultra-light weight projectile at elevated velocities, or any wooden or plastic projectile.

 **Caution**

Fragments of the metal jackets on jacketed bullets may be propelled through the exhaust ports with great force and have the potential to cause injury or property damage at a distance of several feet. The misuse of any of the ammunition described above may result in injury, property damage, or both.

Maintenance: Accumulated debris in the barrel exhaust ports may result in damage to the pistol or injury to the shooter. With the gun unloaded, regularly inspect the bore and exhaust ports for dirt and debris. Never discharge the firearm when any form of debris is present in the barrel or exhaust ports.



Always wear eye and ear protection when using any firearm.

AG-9 SLIDE PART LIST

1	SLIDE	12	EJECTOR PIN (FRONT)
2	FRONT SIGHT	13	FIRING SPRING DETECTOR PART
3	FIRING PIN SAFETY BLOCK PIN	14	FIRING PIN SAFETY BLOCK
4	REAR SIGHT	15	FIRING PIN SAFETY BLOCK SPRING
5	FIRING PIN SPRING (FRONT)	16	EJECTOR
6	FIRING PIN	17	BARREL
7	FIRING PIN INDICATOR	18	RECOIL SHAFT FRAME
8	FIRING PIN SPRING	19	RECOIL PIN SPRING
9	FIRING SPRING PIN	20	RECOIL SHAFT INTERIM PART
10	EJECTOR PIN (REAR)	21	RECOIL SHAFTINTERIM PART SPRING
11	EJECTOR SPRING	22	RECOIL SHAFT

AG-9 SLIDE (PART LIST)

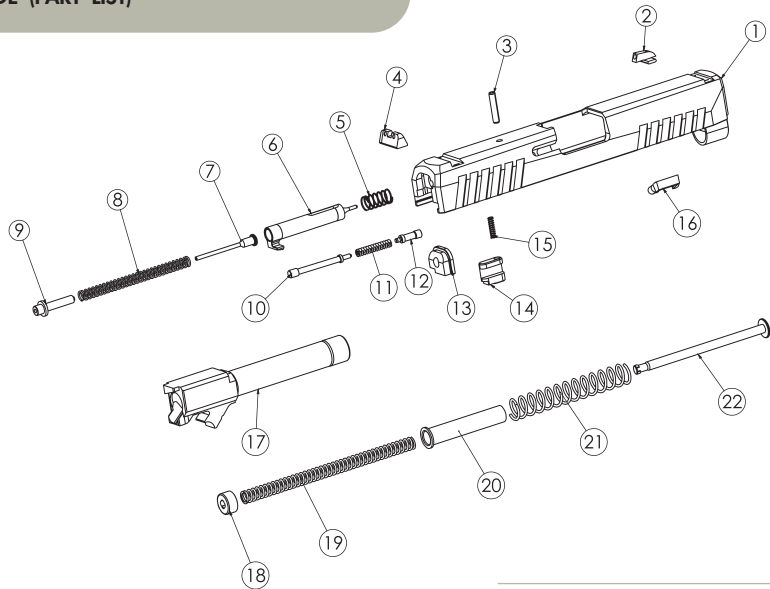

Figure 29

AG-9 FRAME PART LIST

15 FIRING PIN SAFETY BLOCK SPRING

23 DISASSEMBLY LEVER

24 FRAME

25 SLIDE RECOIL CATCH

26 SLIDE RECOIL CATCH SPRING

27 TRIGGER RETAINER PIN

28 FRONT SLIDE

29 TRIGGER SPRING

30 TRIGGER

31 TRIGGER SAFETY PIN

32 TRIGGER SAFETY

33 FRONT SLIDE PIN

34 TRIGGER PIN

35 MAGAZINE LEVER SPRING

36 MAGAZINE LEVER

37 TRIGGER BAR

38 TRIGGER BAR PIN

39 HAMMER CATCH PIN

40 EXTRACTOR PIN

41 SERIAL NUMBER PLATE

42 EXTRACTOR

43 HAMMER CATCH SPRING

44 HAMMER CATCH

45 HAMMER SAFETY
BLOCK DECOCKER

46 MAGAZINE

AG-9 FRAME PART LIST

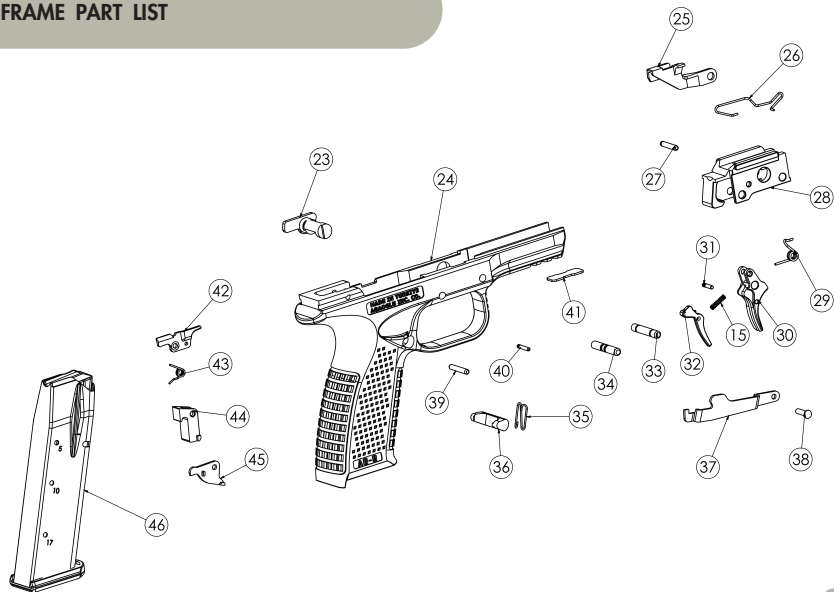

Figure 31

POINT OF AIM

Point of Impact

Shooters may use a “point of aim” sight picture at 25 yards. This means that, at 25 yards the bullet should impact the target at the point visible at the top of the front sight. Shooters may also use a “6 o’clock” sight picture to strike the center of the target. However, some pistols may shoot “point of aim” at 25 yards depending on shooter and ammunition.



“Point of Aim”
Sight Picture

Figure 32-1

Note: Use only clean, dry, original, high-quality, commercially manufactured ammunition.

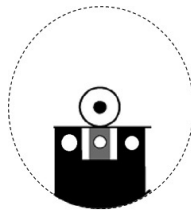

“6 O’Clock”
Sight Picture

Figure 32-2

CARE & CLEANING

KEEP YOUR GUN CLEAN AT ALL TIMES

Basic materials needed:

Cleaning rod of proper size with bristle bore brushes (fiber or brass) and tip into which cleaning patch can be inserted.

- Cloth patches
- Powder solvent
- Lubricating oil
- Small lint-free cloths for wiping and oiling
- Bristle brush for scrubbing dirt off breech face, extractor, magazine lips, follower, etc.

Use proper size bore brushes and patches - if they are too small they won't do the job, and if they are too large they will bind inside bore.

When possible, insert cleaning rod from chamber end of bore and push rod all the way through so it emerges from muzzle.

Do not "reverse" rod direction when patch or brush is in barrel, it might bind.

Do not use patches dripping with solvent or oil. Wet patches or brushes, then squeeze out excess before using. When using bore brushes or a larger bristle brush on breech face, breech areas, magazines, etc., work carefully to prevent damaging components.

 **Wear eye protection when using solvent. Thoroughly wash your hands to remove powder and solvents after cleaning your gun.**

Note: If lower parts of receiver and its mechanism are especially dirty, soak in appropriate solvent, or flush clean with same solvent. Make certain that all foreign matter is removed after cleaning. Lightly oil after cleaning. Only a very small amount of oil is needed to adequately lubricate moving parts and prevent rust. Accumulation of oil tends to attract dust and dirt which interferes with the safe and reliable functioning of pistol. Do not apply excess lubricating oil.

CLEANING PISTOL

1. Point gun in safe direction.
2. Remove magazine and empty chamber.
3. Separate cartridges from pistol before cleaning operation.
4. Open slide and visually check that chamber and magazine well are free of cartridges.
5. Disassemble pistol as described in the DISASSEMBLY Section.
6. Using cleaning rod, run solvent-wetted patch through barrel several times.
7. Attach solvent-wetted bristle brush to rod and run back and forth full length of bore as needed until clean of grease and dirt.
8. Clean barrel with dry patches and examine it. If necessary, repeat barrel scrubbing. Bore fouling can contribute to reduced accuracy, and grease accumulation in the chamber can interfere with proper feeding of cartridges from magazine.
9. Using powder solvent on a clean patch, remove powder residue from all components of mechanism. If grease or dirt cannot be removed by wiping with patch, use solvent-wetted bristle brush.
10. Next, wipe scrubbed areas with solvent wetted patch.
11. After cleaning, run dry patch through barrel, then follow with lightly-oiled patch
12. Wipe all surfaces clean with cloth, then wipe all surfaces with lightly-oiled patch (or cloth).
13. Reassemble pistol. Remember, an improperly assembled firearm is dangerous and should not be fired.
14. Always consult an experienced gunsmith if you experience any difficulty or have any questions concerning assembly procedure.
15. If pistol is to be stored for an extended period, final oil wiping can be heavier so there will be less tendency for it to evaporate.
16. Keep your gun clean at all times.

NOTICE: DISCLAIMER OF LIABILITY

AĞAOĞLU AVIATION AND DEFENSE INDUSTRY CO., LTD. WILL NOT BE RESPONSIBLE FOR THE RESULTS OF CARELESS HANDLING, UNAUTHORIZED REPAIRS AND ADJUSTMENTS, CORROSION, NEGLIGENCE, UNREASONABLE OR UNSAFE USE.

AĞAOĞLU AVIATION AND DEFENSE INDUSTRY CO., LTD. ASSUMES NO RESPONSIBILITY FOR DAMAGE AND/OR INJURY CAUSED IN WHOLE OR IN PART BY HANDLOADED, RELOADED OR DEFECTIVE AMMUNITION. UNDER NO CIRCUMSTANCES SHALL AĞAOĞLU AVIATION AND DEFENSE INDUSTRY CO., LTD. BE RESPONSIBLE FOR INCIDENTAL OR CONSEQUENTIAL DAMAGES WITH RESPECT TO ECONOMIC LOSS OR INJURY TO PROPERTY ARISING OUT OF USE OF HANDLOADED OR REMANUFACTURED AMMUNITION, NEGLIGENCE, UNSAFE HANDLING, OR UNAUTHORIZED MODIFICATIONS TO THE FIREARM.

SOME STATES DO NOT ALLOW THE EXCLUSION OR LIMITATION OF INCIDENTAL OR CONSEQUENTIAL DAMAGES, SO THE ABOVE LIMITATIONS MAY NOT APPLY TO YOU.

- TECHNICAL SPECIFICATIONS MAY BE ALTERED WITHOUT NOTICE.

WARNING!

 The AG-9 Pistol is classified as a firearm and dangerous weapon. Injury or death to you or others may result from unsafe or improper use.

WARRANTY

The manufacturer "AĞAOĞLU AVIATION AND DEFENSE INDUSTRY LIMITED COMPANY" guarantees for all parts of the pistol. The warranty is effective on the date of purchase and covers manufacturing and material defects. This warranty is valid as provided that the warranty certificate is filled in properly and bears the seal of an authorized dealer (shop). Manufacturer and dealer; It is not liable for misuse, damaged and defective ammunition, negligent use of the pistol, damages caused by unauthorized repairs and / or modifications to the pistol, or damage due to misuse and / or misuse of the pistol for any reason, and is not covered by this warranty.

The warranty period is 12 months, unless stated differently in a separate contract.

The customer's; "Warranty Card" must bear the seal and signature of an authorized dealer in order to benefit from all rights and benefits of our product warranty. Otherwise, the customer will not be entitled to any warranty.

WARRANTY CARD

Brand:

Model:

Serial Number:

Date of Purchase:

Warranty Period:

Seal and signature of the authorized dealer / Store:



Şerifali Mahallesi Hattat Sokak No: 51 ÜMRANIYE, İSTANBUL / TÜRKİYE
Tel: 0 (216) 527 1818 • Fax: 0 (216) 527 1829 info@ahss.com.tr www.ahss.com.tr